

Provided by: Mega Hertz | 800-883-8839 | info@go2mhz.com | www.go2mhz.com



Handholes & Vaults

Canyon Modular Vaults Tech Feature

- 1 Modular**
Panels in 12" & 24" height
Stack to increase height
Field replaceable
- 2 Optional sealed entry**
Fast knock out
Mechanical reducer/seal
- 3 Quick Clip**
No bolts, nuts, or tools
Installs in less than half the time
- 4 Optional Floor**
Clean environment
Prevents vegetation
Anti-slip

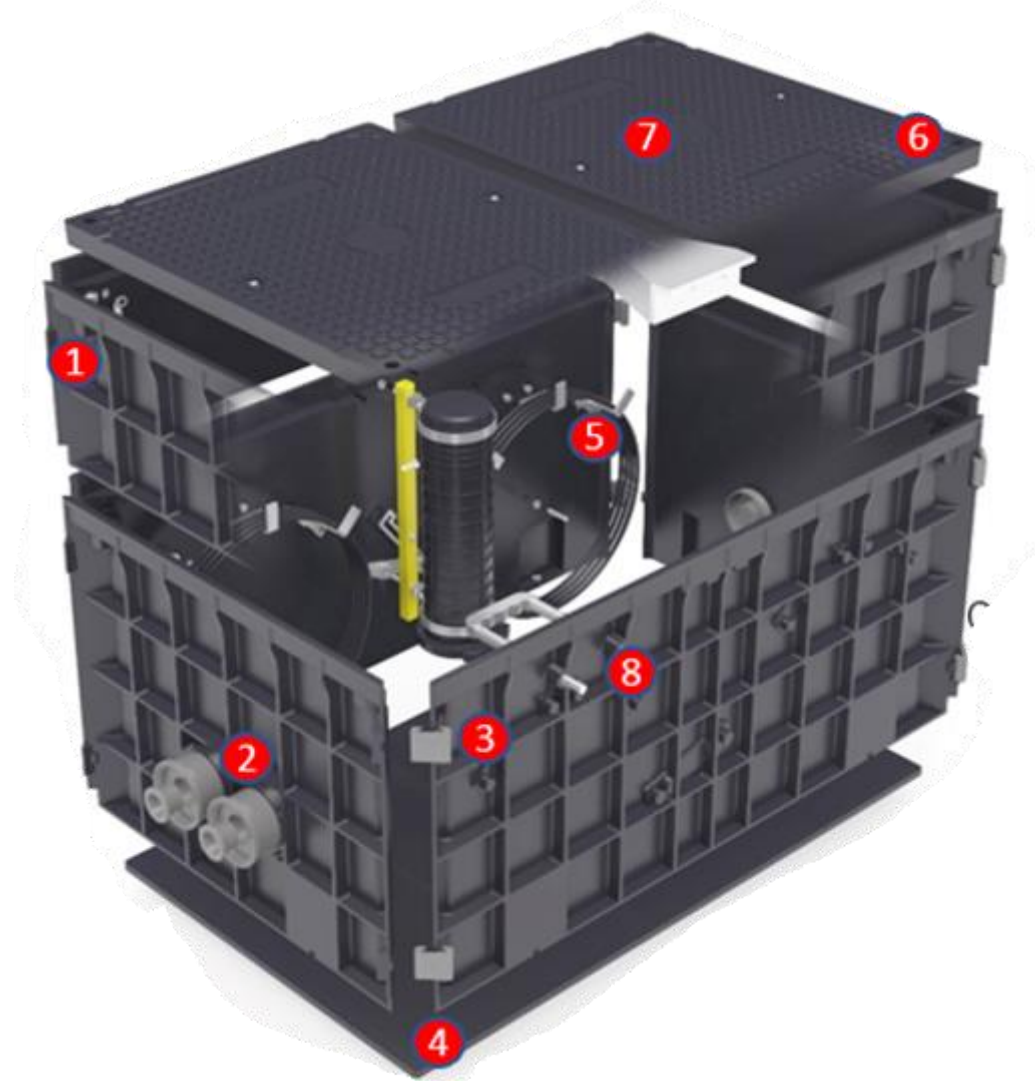

- 5 Storage & Mounting Options**
Clean access & max storage
Application customizable
- 6 Covers**
Stainless hex bolt or custom locking
Cabinet mountable
- 7 Customer Logo**
Customer logo on metal plate
Easy install and customization
- 8 Knock Down = ships flat on pallet**
Low transport cost.
70% faster install vs. concrete

Customizable, Space Saving, Light, Strong, *Grab-n-Go Modular Solution*

SCTE 77 Vault Ratings = Use Case

APPLICATION	LOADING REQUIREMENTS			
Light Duty Pedestrian Traffic Only	Vertical	Test Load	13.3kN	3000 pounds
TIER 5 Sidewalk applications with a safety factor for occasional non-deliberate vehicular traffic	Vertical	Design Load	22.2 kN	5000 pounds
	Lateral	Test Load	33.3 kN	7500 pounds
Lateral		Design Load	28.7 kPa	600 pounds/sq.ft.
	Lateral	Test Load	43.1 kPa	900 pounds/sq.ft. (1800/2700 pounds/ lateral load plate)
TIER 8 Sidewalk applications with a safety factor for non-deliberate vehicular traffic		Vertical	Design Load	35.6 kN
	Lateral	Test Load	53.4 kN	12000 pounds
Lateral		Design Load	28.7 kPa	600 pounds/sq.ft.
	Lateral	Test Load	43.1 kPa	900 pounds/sq.ft. (1800/2700 pounds/ lateral load plate)
TIER 15 Driveway, parking lot, and off-roadway applications subject to occasional non-deliberate heavy vehicular traffic		Vertical	Design Load	66.7 kN
	Lateral	Test Load	100.1 kN	22500 pounds
Lateral		Design Load	38.3 kPa	800 pounds/sq.ft.
	Lateral	Test Load	57.5 kPa	1200 pounds/sq.ft. (2400/3600 pounds/ lateral load plate)
TIER 22 Driveway, parking lot, and off-roadway applications subject to occasional non-deliberate heavy vehicular traffic		Vertical	Design Load	100.1 kN
	Lateral	Test Load	150.1 kN	33750 pounds
Lateral		Design Load	38.3 kPa	800 pounds/sq.ft.
	Lateral	Test Load	57.5 kPa	1200 pounds/sq.ft. (2400/3600 pounds/ lateral load plate)
AASHTO H-20 Deliberate vehicular traffic applications.		Certified precast concrete, cast iron, or AASHTO-recognized materials.		

Table 1 – Design / Test Loads

Light Duty: Flowerpot & Handholes

- **10x14x10 Flowerpot**
- 12x12x12 Handhole
- **12x16x12 Handhole**
- Modular vaults available in 90 days

Tier 5: Need Opportunity

- Modular vaults available in 90 days
- Pads are Tier 5 for handling ease

Tier 15 & Tier 22 Modular Vaults

- **Available now & in stock**
- **12x12x12**
- **12x18x18**
- **17x30x24**
- **24x36x24**
- **30x48x36**

17x30 Modular Vault Anatomy

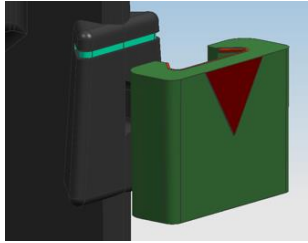

Quick Clip Fastener

Base Height: 24"



**24"
Base**

S: Short Side Wall

L: Long Side Wall

High Rise: 36"



**12"
Riser**

**24"
Base**

RS: Riser Short Side Wall

RL: Riser Long Side Wall

Ultra High Rise: 48"

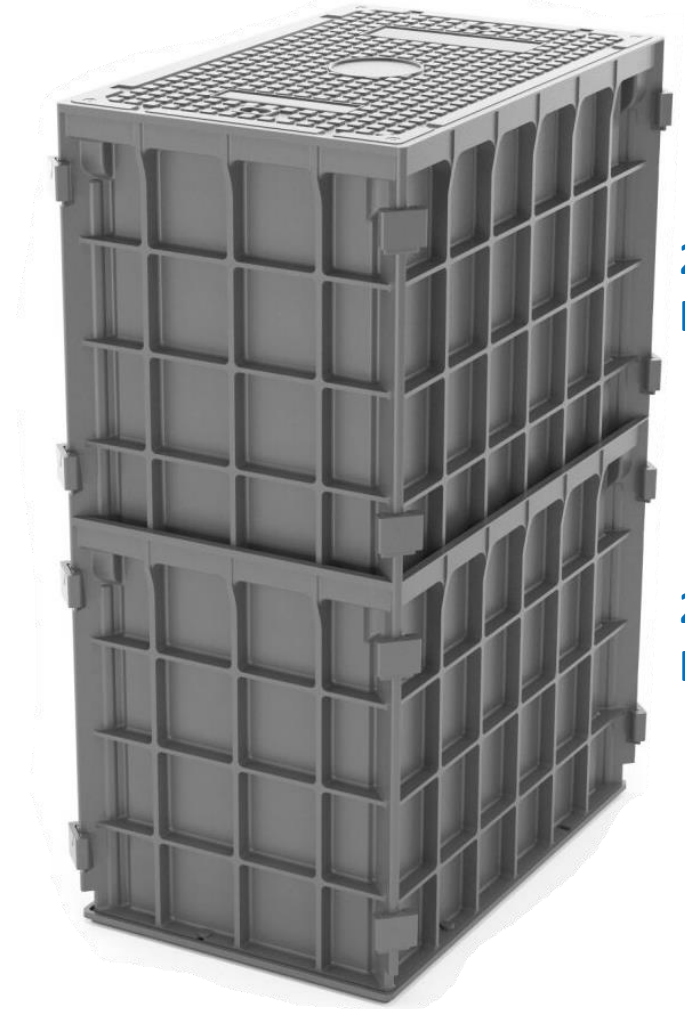

**24"
Base**

**24"
Base**

Vault Accessories

Name Plate

- Included per Lid

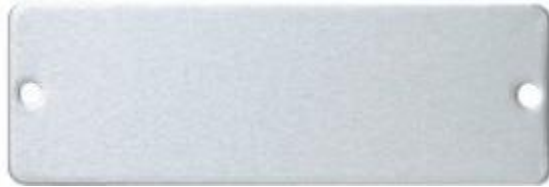

Cover Hook

- 2x Included

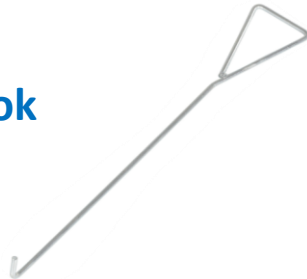

Fiber Hooks

- Included



Smart Ball ID Marker

- Read/Write @ 2'
- 360 Sense @ 5'
- 50yr. life
- Application colors



Smart Coin ID Marker

- Read/Write @ 1.5'
- 360 Sense @ 2'
- 50yr. life
- Application colors



Grounding Plate

- Galvanized Steel
- With Connector

Released Handholes and Vaults

- *** Standard sizes**
- **Optional colors available**

Modular Handholes

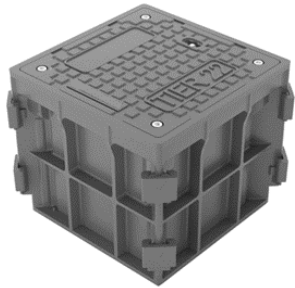

12x12x12*



12x18x18*

**Modular Vaults &
Handholes Rated
Tier 15 & 22**

Light Duty Handholes



12x16x12*



**6x9x9
10x14x10***

Small Modular Vault



17x30x24*
17x30x36
17x30x48



Medium Modular Vault

24x36x24*
24x36x36
24x36x48



Large Vault

30x48x36*

Advantage of SureAlign Vaults Solution

Lightweight & stronger than steel: Maintains shape in all environments

Easy, Fast Install: No crane, no Tools, easy to use

Environmental resistant: Doesn't degrade, deteriorate or break if dropped

Modularity: Stack to add depth, ships flat, field replaceable parts

Easy transport and low logistics cost: 20 vaults per pallet, easy to lift

Radio Friendly: Allows location radio signals to be read

SureAlign Vault-1730 Series Tier 22 Ordering Info



Order Assembly Part

- Includes: Vault + Accessories

- S = short side
- L = long side
- C = cover
- RS = Riser short side
- RL = Riser long side

- Includes Accessories:

- Clips for corner connections
- SS Bolts and Nuts for cover
- 4x Fiber J brackets w/ mount
- ID Marker bracket w/ mount
- 2x Cover lifting hooks

	SA-HDV-1730A	SA-HDV-1730B	SA-HDV-1730C
MOQ: 20 pcs. Ships: 3 pallets <ul style="list-style-type: none"> 40 Short Side 40 Long Side 20 Covers 			
Internal Size (inch) WxLxH	17x30x24	17x30x36	17x30x48
External Size (inch) WxLxH	21x33x24	21x33x36	21x33x48
Weight (lbs)	109.25	147.17	170.53
Side Wall parts included			
SA-HDVP-1730S	2	2	4
SA-HDVP-1730L	2	2	4
SA-HDVP-1730C	1	1	1
SA-HDVP-1730RS	0	2	0
SA-HDVP-1730RL	0	2	0

Order Spare Part

- Ala-carte ordering of individual vault walls
- See accessories page for ordering information

Side Wall Parts	Description	Size (inch)	Weight (lbs)
SA-HDVP-1730S	Short Side Wall for SA-HDV-1730A/B/C	22x24	13.36
SA-HDVP-1730L	Long Side Wall for SA-HDV-1730A/B/C	34x24	17.28
SA-HDVP-1730C	Cover for SA-HDV-1730A/B/C	21x32	47.97
SA-HDVP-1730RS	Riser-Short Side Wall for SA-HDV-1730B	22x12	8.16
SA-HDVP-1730RL	Riser-Long Side Wall for SA-HDV-1730B	34x12	10.8

SureAlign Vault-2436 Series Tier 22 Ordering Info

Order Assembly Part

- Includes: Vault + Accessories



- S = short side
- L = long side
- C = cover
- RS = Riser short side
- RL = Riser long side

- Includes Accessories:

- Clips for corner connections
- SS Bolts and Nuts for cover
- 4x Fiber J brackets w/ mount
- ID Marker bracket w/ mount
- 2x Cover lifting hooks

Order Spare Part

- Ala-carte ordering of individual vault walls
- See accessories page for ordering information

	SA-HDV-2436A	SA-HDV-2436B	SA-HDV-2436C
MOQ:20 pcs. Ships: 3 pallets			
<ul style="list-style-type: none"> 40 Short Side 40 Long Side 20 Covers 			
Internal Size (inch) WxLxH	24x36x24	24x36x36	24x36x48
External Size (inch) WxLxH	27x39x24	27x39x36	27x39x48
Weight (lbs)	158.15	204.89	244.65
Side Wall parts included			
SA-HDVP-2436S	2	2	4
SA-HDVP-2436L	2	2	4
SA-HDVP-2436C	1	1	1
SA-HDVP-2436RS	0	2	0
SA-HDVP-2436RL	0	2	0

Side Wall Parts	Description	Size (inch)	Weight (lbs)
SA-HDVP-2436S	Short Side Wall for SA-HDV-2436A/B/C	26x24	19.97
SA-HDVP-2436L	Long Side Wall for SA-HDV-2436A/B/C	39x24	23.28
SA-HDVP-2436C	Cover for SA-HDV-2436A/B/C	26x39	71.65
SA-HDVP-2436RS	Short-Short Side Wall for SA-HDV-2436B	26x12	9.7
SA-HDVP-2436RL	Short-Long Side Wall for SA-HDV-2436B	39x12	13.67

SureAlign Vault-3048 Series Tier 22 Ordering Info

Order Assembly Part



- **Includes: Vault + Accessories**

- S = short side
- L = long side
- C = cover
- RS = Riser short side
- RL = Riser long side

- **Includes Accessories:**

- SS Assembly hardware
- SS Bolts and Nuts for cover
- 4x Fiber J brackets w/ mount
- ID Marker bracket w/ mount
- 2x Cover lifting hooks

SA-HDV-3048	
MOQ: 10 pcs. Ships: 3 pallets <ul style="list-style-type: none"> • 20 Short Side • 20 Long Side • 20 Covers 	
Internal Size (inch) WxLxH	30x48x36
External Size (inch) WxLxH	32x50x36
Weight (lbs)	326.98
Side Wall parts included	
SA-HDVP-2436S	2
SA-HDVP-2436L	2
SA-HDVP-2436C	2

Order Spare Part

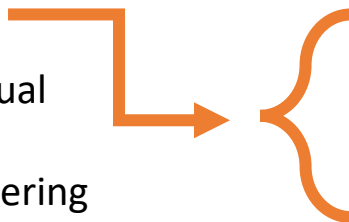











- Ala-carte ordering of individual vault walls
- See accessories page for ordering information











Side Wall Parts	Description	Size (inch)	Weight (lbs)
SA-HDVP-3048S	Short Side Wall for SA-HDV-3048	33x36	34.96
SA-HDVP-3048L	Long Side Wall for SA-HDV-3048	51x36	61.33
SA-HDVP-3048C	Cover for SA-HDV-3048	26x39, 2 Lids	67.2

SureAlign Vault Accessory Spares

17x30 & 24x36

Assemble P/N	Specifications	QTY	Description	Reference Picture
SA-HDV-ACC-CL652	Clip, Dimension 63x50x22 mm	8	Connect Side walls	
SA-HDV-ACC-SHSM1270	Socket Head Screw, M12X70 mm	4	Fasten lid onto walls	
SA-HDV-ACC-NUTM12	Nut, M12	4	Buried into Side wall, work with screw	
SA-HDV-ACC-SHSM1216	Socket Head Screw, M12X16	1	Fasten and unfasten the screw	
SA-HDV-ACC-BKT822	J-Bracket, Dimension 80x25x25 mm	4	Holding FOSC or loop cable	
SA-HDV-ACC-STSM419	Self-tapping Screw, M4X19 mm	8	Fasten J-Bracket onto walls	
SA-HDV-ACC-MC75	Marker Case, Diameter 75 mm	1	Holding marker in, at lid back	
SA-HDV-ACC-SHSM1016	Socket Head Screw, M10X16	1	Screw Marker Case at lid back	
SA-HDV-ACC-WasherM10	Washer, 11X20mm (inner and outer diameter)	1	Fasten on Marker Case	
SA-HDV-ACC-HK30	Hook, S.S 30mm Long	2	Per 2 vault equip 1 pair of hook	

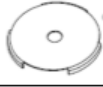
30x48

Assemble Parts	Specifications	QTY	Description	Reference Picture
SA-HDV-ACC-HHSM12100	Hex Head Screw, M12X100mm	4	Fasten lid onto walls	
SA-HDV-ACC-SNUTM12	Square Nut, M12, Customized	4	Buried into walls, work with lid screw	
SA-HDV-ACC-SNC3020	Square Nut Case, 31X20mm	4	Load square nut into walls	
SA-HDV-ACC-FHSM610	Flat Head Screw, Cross pattern, Flat Head	8	Fasten nut case onto walls	
SA-HDV-ACC-HSDM12	HEX Screw Driver for HEX Head M12	1	Fasten and unfasten the screw	
SA-HDV-ACC-BKT822-1	J-Bracket1, Dimension 80x25x25mm, big hole	4	Holding FOSC or loop cable	
SA-HDV-ACC-HHSM820	Hex Head Screw, M8X20mm	8	Fasten J-Bracket onto walls	
SA-HDV-ACC-HHSM860	Hex Head Screw, M8X60mm	12	Fasten 2 walls	
SA-HDV-ACC-NUTM8	M8 Nut	20	For J-Bracket and wall connecting bolt	
SA-HDV-ACC-MC75	Marker Case, Diameter 75mm	1	Holding marker in, at lid back	
SA-HDV-ACC-SHSM1016	Socket Head Screw, M10X16	1	Screw Marker Case at lid back	
SA-HDV-ACC-WasherM10	Washer, 11X20mm (in and out diameter)	21	Fasten on Marker Case, J-Bracket, and Wall connect Bolt	
SA-HDV-ACC-HK30	Hook, S.S 30mm Long	2	Per 2 vault equip 1 pair of hook	