

## SA-HDV-3048 Vault Series

SureAlign SA-HDV-3048 Series Vault system is SCTE77-Tier22 load capacity, designed for underground network access, especially for fiber optical and electricity industries. Manufactured with innovated composite material, making SA-HDV-3048 Vault Series an ideal solution of strong, light, flexible, time & cost saving comparing to concrete manholes.

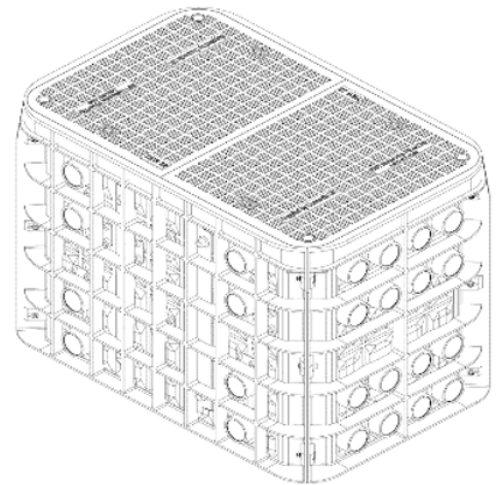

### Technical Features

**1 Knock-down and delivered with flat package**

Low transport cost.  
Fast set up on site.  
70% time saving compared to concrete.  
No heavy truck to lift.

**2 Duct Entry Provision**

Fast knock-out entry.  
Duct reducer and sealing.

**3 Fast-Clip connecting kit**

No bolt or tool required.  
50% time saving.

**4 Bottom plate (Optional)**

Base provide a clean finish.  
Anti-slip and prevent vegetation.

**5 Cable & Closure bracket**

Provide slack cable storage.  
Hold closure.

**6 Optional locking system**

**7 Customer logo**  
Customized on cover available

**8 Ladder (Optional)**

For easy and safe access into manhole

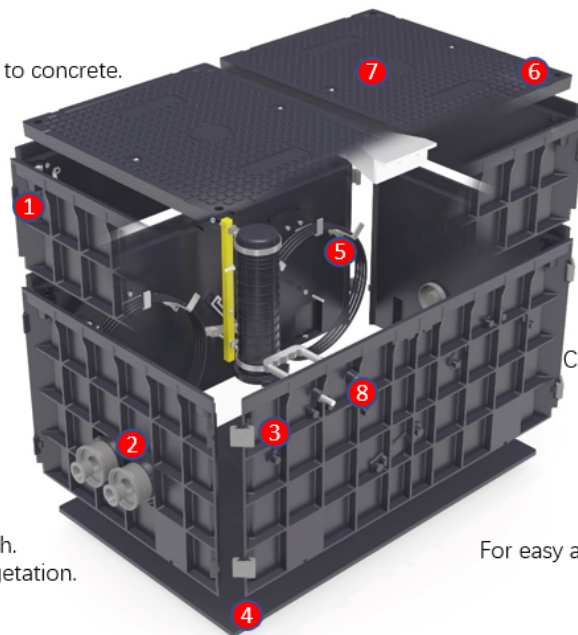

## TESTING CRITERIA







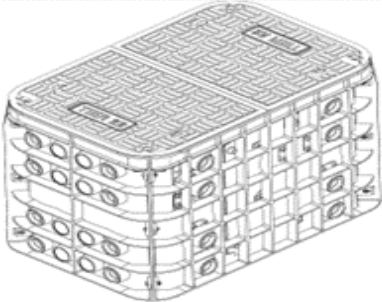





Covers and bodies all meet or exceed:

- ANSI/SCTE 77 2013-TIER 22
- EST™ 3 Million Cycles
- Telcordia GR-902-CORE
- Western Underground Committee Guide 3.6
- EN124 Class B125
- AS3996-Class B/C

## Order & Specification Information:

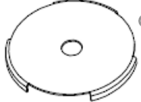
<b>Vault Model#</b>	<b>SA-HDV-3048</b>
<b>Outlook</b>	
<b>Internal Size (inch) WxLxH</b>	30x48x36
<b>External Size (inch) WxLxH</b>	32x50x36
<b>Weight (lbs)</b>	326.98
<b>Side Wall parts included</b>	
<b>SA-HDVP-2436S</b>	2
<b>SA-HDVP-2436L</b>	2
<b>SA-HDVP-2436C</b>	2

<b>Side Wall Parts</b>	<b>Description</b>	<b>Size (inch)</b>	<b>Weight (lbs)</b>
<b>SA-HDVP-3048S</b>	Short Side Wall for SA-HDV-3048	33x36	34.96
<b>SA-HDVP-3048L</b>	Long Side Wall for SA-HDV-3048	51x36	61.33
<b>SA-HDVP-3048C</b>	Cover for SA-HDV-3048	26x39, 2 Lids	67.2

Assemble Parts	Specifications	QTY	Description	Reference Picture
SA-HDV-ACC-HHSM12100	Hex Head Screw, M12X100mm	4	Fasten lid onto walls	
SA-HDV-ACC-SNUTM12	Square Nut, M12, Customized	4	Buried into walls, work with lid screw	
SA-HDV-ACC-SNC3020	Square Nut Case, 31X20mm	4	Load square nut into walls	
SA-HDV-ACC-FHSM610	Flat Head Screw, Cross pattern, Flat Head	8	Fasten nut case onto walls	
SA-HDV-ACC-HSDM12	HEX Screw Driver for HEX Head M12	1	Fasten and unfasten the screw	
SA-HDV-ACC-BKT822-1	J-Bracket1, Dimension 80x25x25mm, big hole	4	Holding FOSC or loop cable	
SA-HDV-ACC-HHSM820	Hex Head Screw, M8X20mm	8	Fasten J-Bracket onto walls	
SA-HDV-ACC-HHSM860	Hex Head Screw, M8X60mm	12	Fasten 2 walls	
SA-HDV-ACC-NUTM8	M8 Nut	20	For J-Bracket and wall connecting bolt	
SA-HDV-ACC-MC75	Marker Case, Diameter 75mm	1	Holding marker in, at lid back	
SA-HDV-ACC-SHSM1016	Socket Head Screw, M10X16	1	Screw Marker Case at lid back	
SA-HDV-ACC-WasherM10	Washer, 11X20mm (in and out diameter)	21	Fasten on Marker Case, J-Bracket, and Wall connect Bolt	
SA-HDV-ACC-HK30	Hook, S.S 30mm Long	2	Per 2 vault equip 1 pair of hook	 2x

## SA-HDV-3048 External Dimension

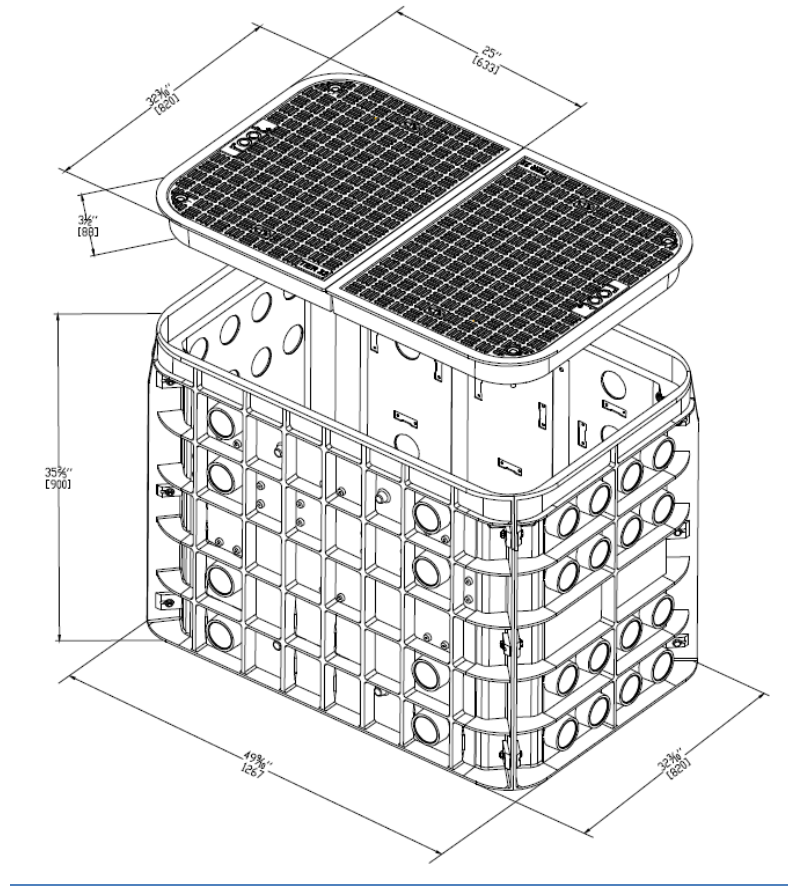

MEGA HERTZ Provided by: Mega Hertz | 800-883-8839 | [info@go2mhz.com](mailto:info@go2mhz.com) | [www.go2mhz.com](http://www.go2mhz.com)

<https://www.go2mhz.com/product/sa-hdv-3048-series-vault-system/>