

SA-HDV-2436 Chamber Series

SureAlign SA-HDV-2436 Series Vault system is SCTE77-Tier22 load capacity, designed for underground network access, especially for fiber optical and electricity industries. Manufactured with innovated composite material, making SA-HDV-2436 Vault Series an ideal solution of strong, light, flexible, time & cost saving comparing to concrete manholes.

SA-HDV-2436 series consist of 3 models, SA-HDV-2436A (base), SA-HDV-2436B (high-rise) and SA-HDV-2436C (ultra high-rise). The innovative “Fast-Clip connecting kit” features no tool required and easy to stack based on SA-HDV-2436A.

Technical Features

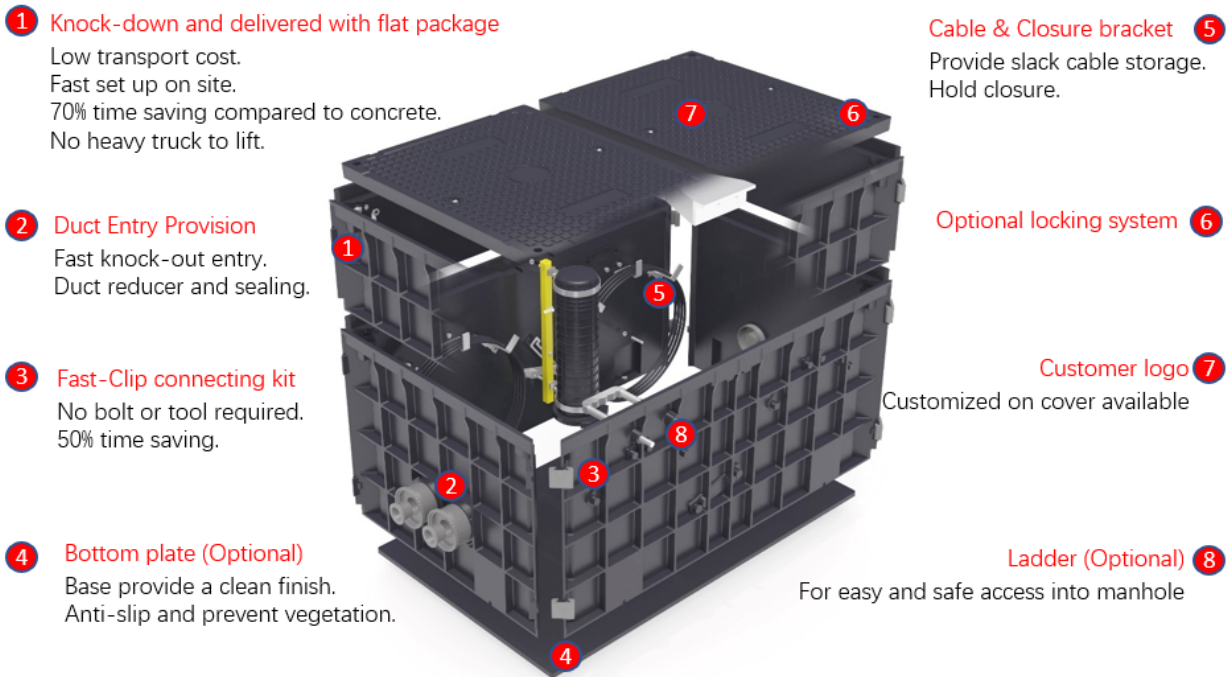

TESTING CRITERIA



Covers and bodies all meet or exceed:



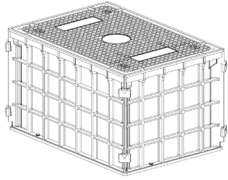
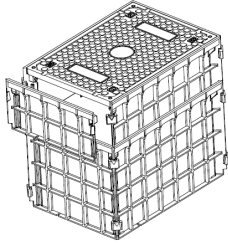
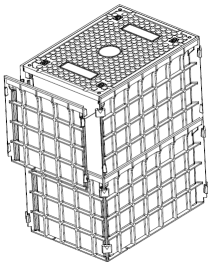

- ANSI/SCTE 77 2013-TIER 22
- EST™ 3 Million Cycles
- Telcordia GR-902-CORE
- Western Underground Committee Guide 3.6
- EN124 Class B125
- AS3996-Class B/C

Order & Specification Information:

Vault Model#	SA-HDV-2436A	SA-HDV-2436B	SA-HDV-2436C
Outlook			
Internal Size (inch) WxLxH	24x36x24	24x36x36	24x36x48
External Size (inch) WxLxH	27x39x24	27x39x36	27x39x48
Weight (lbs)	158.15	204.89	244.65
Side Wall parts included			
SA-HDVP-2436S	2	2	4
SA-HDVP-2436L	2	2	4
SA-HDVP-2436C	1	1	1
SA-HDVP-2436RS	0	2	0
SA-HDVP-2436RL	0	2	0

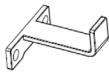
Side Wall Parts	Description	Size (inch)	Weight (lbs)
SA-HDVP-2436S	Short Side Wall for SA-HDV-2436A/B/C	26x24	19.97
SA-HDVP-2436L	Long Side Wall for SA-HDV-2436A/B/C	39x24	23.28
SA-HDVP-2436C	Cover for SA-HDV-2436A/B/C	26x39	71.65
SA-HDVP-2436RS	Short-Short Side Wall for SA-HDV-2436B	26x12	9.7
SA-HDVP-2436RL	Short-Long Side Wall for SA-HDV-2436B	39x12	13.67

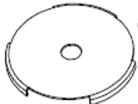
Assemble Parts	Specifications	QTY	Description	Reference Picture
SA-HDV-ACC-CL652	Clip, Dimension 63x50x22 mm	8	Connect Side walls	
SA-HDV-ACC-SHSM1270	Socket Head Screw, M12X70 mm	4	Fasten lid onto walls	
SA-HDV-ACC-	Nut, M12	4	Buried into Side wall, work with screw	

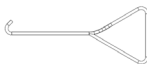
NUTM12				
SA-HDV-ACC-SDM12	Screw Driver for Socket Head M12	1	Fasten and unfasten the screw	
SA-HDV-ACC-BKT822	J-Bracket, Dimension 80x25x25 mm	4	Holding FOSC or loop cable	
SA-HDV-ACC-STSM419	Self-tapping Screw , M4X19 mm	8	Fasten J-Bracket onto walls	
SA-HDV-ACC-MC75	Marker Case, Diameter 75 mm	1	Holding marker in, at lid back	
SA-HDV-ACC-SHSM1016	Socket Head Screw, M10X16	1	Screw Marker Case at lid back	
SA-HDV-ACC-WasherM10	Washer, 11X20mm (in and out diameter)	1	Fasten on Marker Case	
SA-HDV-ACC-HK30	Hook, S.S 30mm Long	2	Per 2 vault equip 1 pair of hook	

SA-HDV-2436A External Dimension

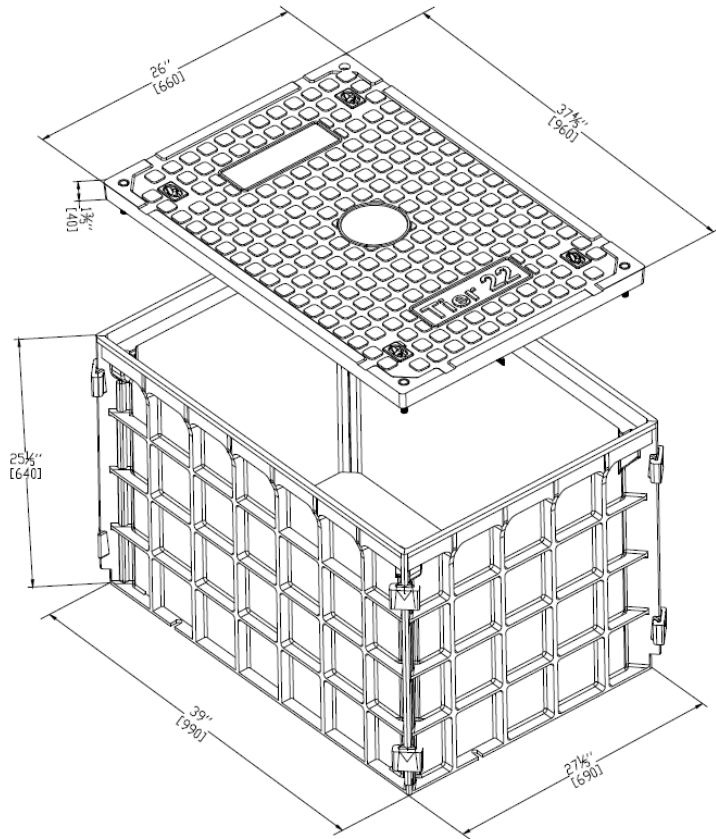

SA-HDV-2436B External Dimension

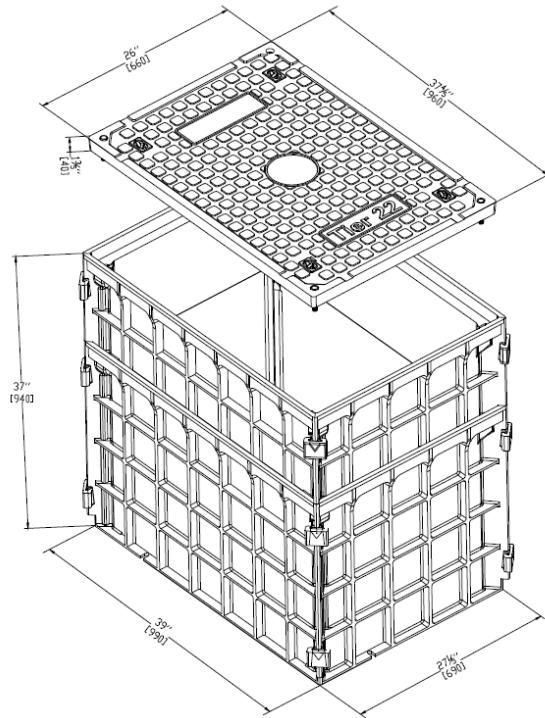

SA-HDV-2436C External Dimension

