

SA-FOSC-4282 Fiber Optic Splice Closure specification

Description

SureAlign SA-FOSC-4282 type of FOSC is designed for connection and protection of fiber cables. This model has one oval port and seven branch cable ports. It can be used for different applications of optical fiber cable splicing & branching and is suitable for aerial, pipe-lined, manhole and direct buried applications. It applies to any sort of cables (loose tube, skeleton, ribbon etc.)

Features

- Cable diameter: 1 uncut port meet $\phi 8\sim 18\text{mm}$ cable, 5 branch ports meet $\phi 8\sim 18\text{mm}$ cable, 2 branch ports meet $\phi 10\sim 20\text{mm}$ cable.
- Capacity: max capacity is up to 144F. Each tray supports 24F.
- Installation method: wall-mounted, pole mounted, manhole and direct burial mounted.
- Closure body is made of polymer modified materials, not only good sealing performance but also durable and user-friendly.
- Sealing: heat shrink sealed is used for cable ports, the waterproof level is IP68.



Specifications

Technical Specification			
Style	Dome		
Dimensions(mm)	510×φ190 mm		
Weight (kg)	2.5		
Material	PP+GF		
Sealing Type	Heat Shrink		
Protection Grade	IP68		
Cable ports	Oval port	1	Φ8mm~18mm
	Round port	7	Φ8mm~18mm
Closure Max Capacity	Single fiber splicing		144f
Splice Tray Capacity	Single fiber splicing per tray		24f
Max No. tray installed	6 pcs		
Installation	Aerial / Wall/ Pole / Manhole mounted		

Structure Drawings

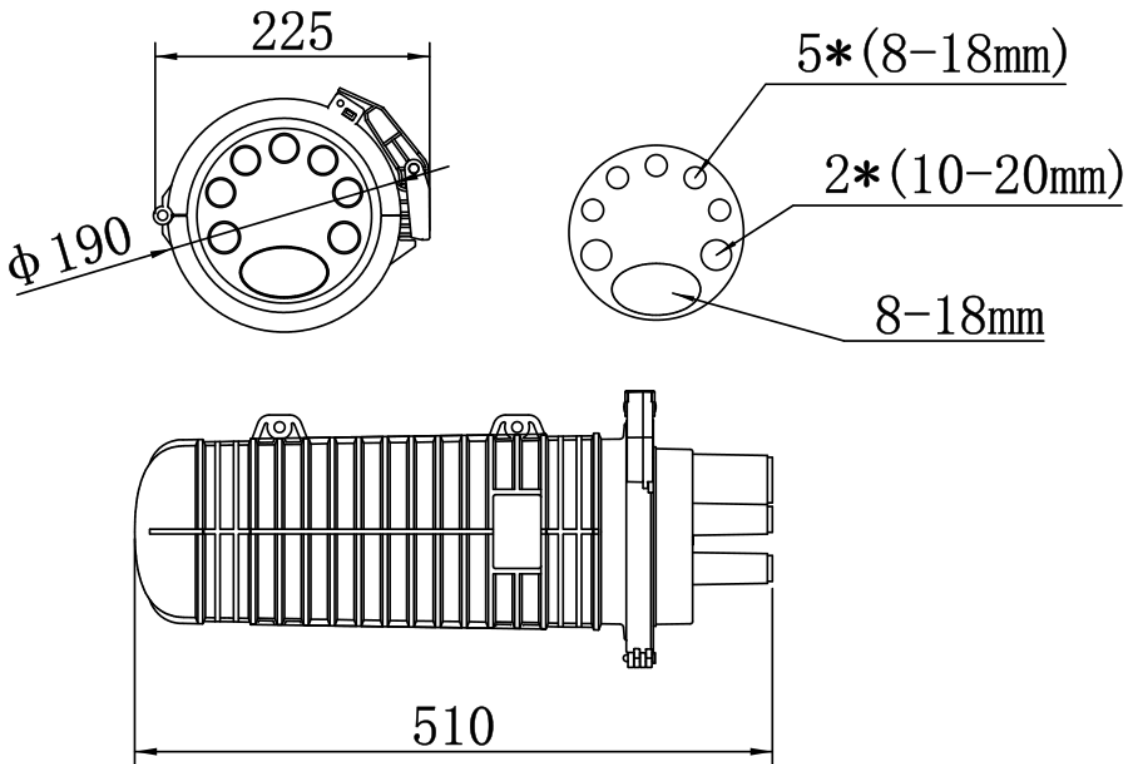











Installation Drawing





Accessory list

Standard accessories

Item	Description	Qty	Picture
1	Big heat shrink tube	1 pc	
2	Small heat shrink tube	7 pcs	
3	Branch kit	1 pc	
4	Insulation tap	1 roll	
5	Splicing protective tube	1 bag	
6	Nylon cable tie	1 bag	
7	Installation manual	1 set	
8	EVA tube	1 roll	
9	Desiccant	1 pc	
10	Clean paper	1 pc	
12	Ground lead	1 set	

Optional accessories

Item	Description	Qty	Picture
1	Air Valve	1 set	
2	Sealing kits	As require	

3	Aerial mounting fittings	1 set	
4	Pole mounting fittings	1 set	
5	Wall mounting fittings	1 set	

Packaging information

Product Dimension	Gift Box Dimension	Outer carton Dimension
510×φ190 mm	523*230*210 mm (1 pcs)	540*480*450mm (4pcs)

Kit Order Information

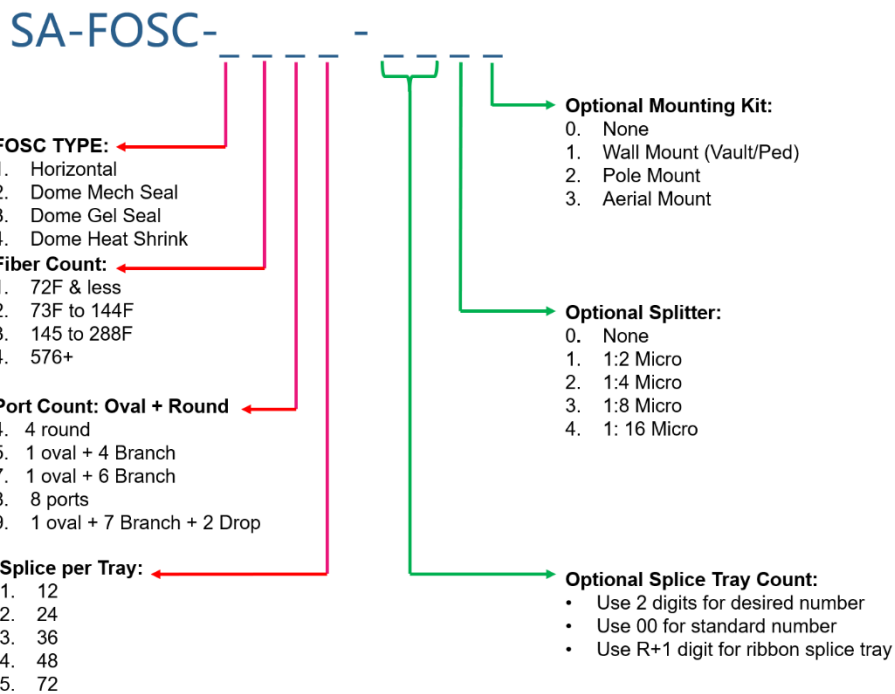

e.g.

Part Number	Description
SA-FOSC-4282-0000	Dome Type Fiber Optic Splice Closure, Heat Shrink, IP68 grade, 1 oval port + 7 round ports. Maximum 144f single fiber splice capacity. 6 trays @ 24f splice capacity.
SA-FOSC-4282-0001	Dome Type Fiber Optic Splice Closure, Heat Shrink, IP68 grade, 1 oval port + 4 round ports. Maximum 144f single fiber splice capacity. 6 trays @ 24f splice capacity. With wall mount kit.
SA-FOSC-4282-0002	Dome Type Fiber Optic Splice Closure, Heat Shrink, IP68 grade, 1 oval port + 7 round ports. Maximum 144f single fiber splice capacity. 6 trays @ 24f splice capacity. With pole mount kit.

SA-FOSC-4282-0003	Dome Type Fiber Optic Splice Closure, Heat Shrink, IP68 grade, 1 oval port + 7 round ports. Maximum 144f single fiber splice capacity. 6 trays @ 24f splice capacity. With aerial mount kit.
-------------------	--

Additional Accessories Order Information

Part Number	Description
SA-FOSC-4282-ACC-0001	additional Wall Mounting Kit for this FOSC
SA-FOSC-4282-ACC-0002	additional Pole Mounting Kit for this FOSC
SA-FOSC-4282-ACC-0003	additional Aerial Mounting Kit for this FOSC
SA-FOSC-4282-ACC-0100	additional Fiber Splice Tray 24F single fiber fusion for this FOSC

Provided by: [Mega Hertz](https://www.megahertz.com) | [800-883-8839](tel:800-883-8839) | info@go2mhz.com | www.go2mhz.com

<https://www.go2mhz.com/product/fiber-optic-splice-closure/>